

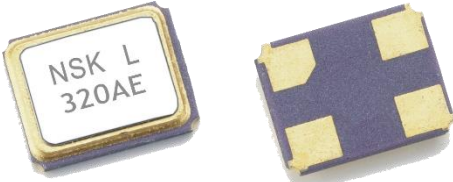











## NXK Series 3.2 x 2.5

  	<b>Application :</b> <ul style="list-style-type: none"> <li> Office automation equipment</li> <li> Audio-visual equipment</li> <li> Radio communication</li> <li> TCXO</li> <li> GPS</li> </ul>
	<b>Features :</b> <ul style="list-style-type: none"> <li> Packing in embossed carrier tape realize auto SMT</li> <li> Excellent vibration resistance &amp; shock resistance</li> <li> RoHS compliant / Pb free</li> <li> Excellent solderability</li> <li> Seam welding</li> </ul>

## Electrical Specification :

Model	NXK-32
<b>1. Frequency</b>	
Frequency Range	12.0 ~ 156.0 MHz
Frequency Tolerance at 25°C±2°C	±10 ~ ±50 ppm (TYP.)
Frequency Stability Over Operating Temp Range	±10 ~ ±50 ppm (TYP.)
<b>2. Environmental Condition</b>	
Operating Temp Range	-10°C~ +60°C, -20°C~ +70°C or specify
Storage Temp Range	-40°C ~ +125°C
Aging Rate	±3ppm/year
<b>3. Electrical Specifications</b>	
Test Circuit	S&A 250B
Load Capacitance	6pF ~ 32pF, series or specify
Drive Level	1uW ~ 100uW or specify
Shunt Capacitance	3.0pF max

\* Above specification subject to change without prior notice, please consult our sales representative for more information\*

### TAIWAN — JENJAAN QUARTEK CORPORATION

Address : 3F-5, No 504 Yun Shan Road, Chung Ho City, Taipei, Taiwan  
 Tel : +886-2-8221-4498 Fax : +886-2-8221-4499  
 E-mail : jenjaan@jenjaan.com.tw Web : http://www.nsk.com.tw

### FACTORY - DONG GUAN ALLIED PROJECT LIMITED

Address : No. 703, Fu Min Zhong Road, Yang Yong Village, Dalang  
 Town, Dong Guan, Guang Dong, China Tel : +86-769-8311-9395  
 Fax : +86-769-8313-0880 E-mail : alliedj@pub.dgnet.gd.cn

## Equivalent Series Resistance (ESR) V.S. Frequency:

Frequency (MHz)	Oscillation Mode	NXK-32
12.0 MHz ~ 13.0 MHz	Fundamental	120Ω
13.1 MHz ~ 20.0 MHz	Fundamental	100Ω
20.1 MHz ~ 26.0 MHz	Fundamental	80Ω
26.1 MHz ~ 66.0 MHz	Fundamental	50Ω
60.0 MHz ~ 156.0 MHz	3 <sup>rd</sup> Overtone	100Ω

## Dimensions (mm) :

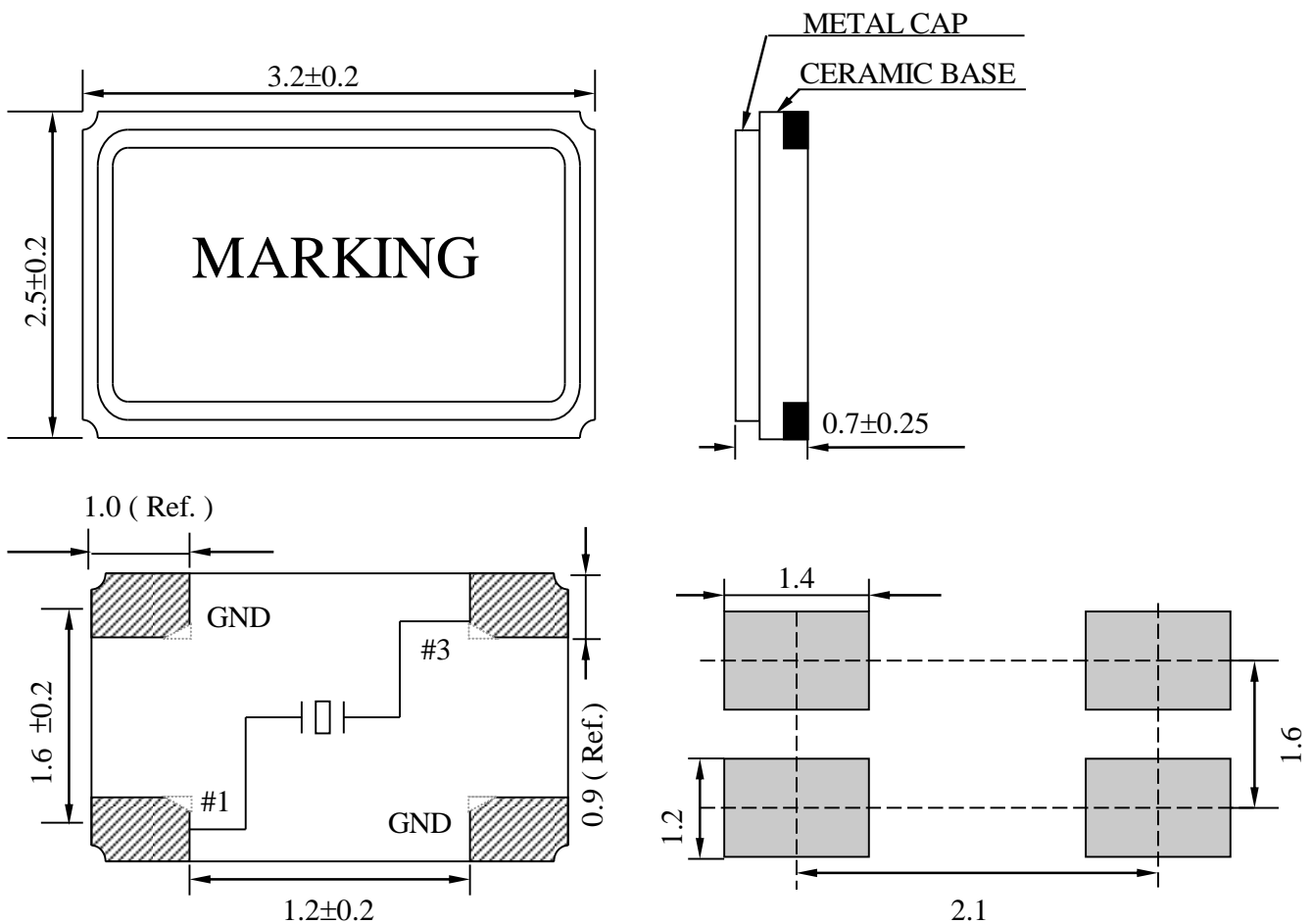

\* Above specification subject to change without prior notice, please consult our sales representative for more information\*

### TAIWAN — JENJAAN QUARTEK CORPORATION

Address : 3F-5, No 504 Yun Shan Road, Chung Ho City, Taipei, Taiwan  
 Tel : +886-2-8221-4498 Fax : +886-2-8221-4499  
 E-mail : jenjaan@jenjaan.com.tw Web : http://www.nsk.com.tw

### FACTORY - DONG GUAN ALLIED PROJECT LIMITED

Address : No. 703, Fu Min Zhong Road, Yang Yong Village, Dalang  
 Town, Dong Guan, Guang Dong, China Tel : +86-769-8311-9395  
 Fax : +86-769-8313-0880 E-mail : alliedj@pub.dgnet.gd.cn

## Tape Specification(mm) :

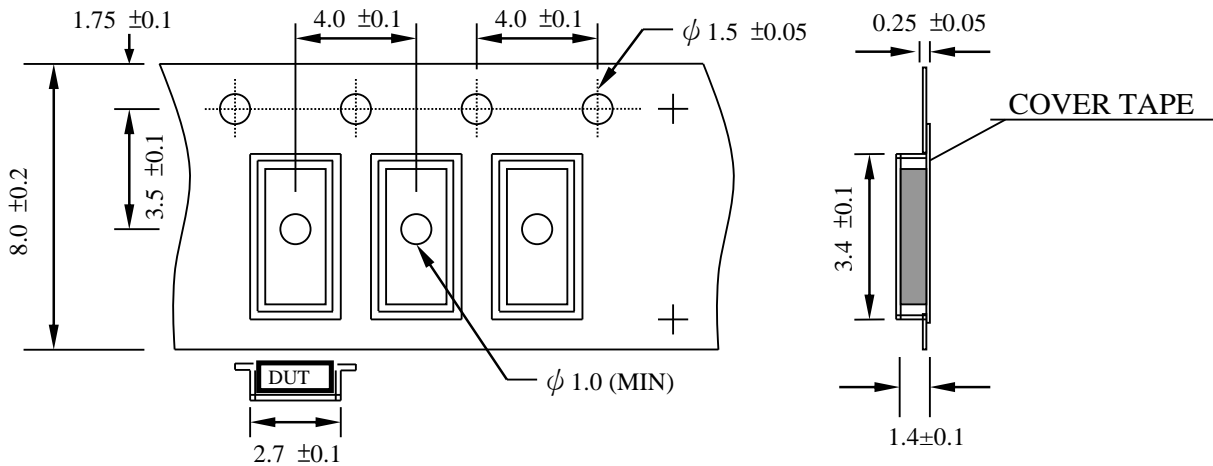

## Reel Packing(mm) :

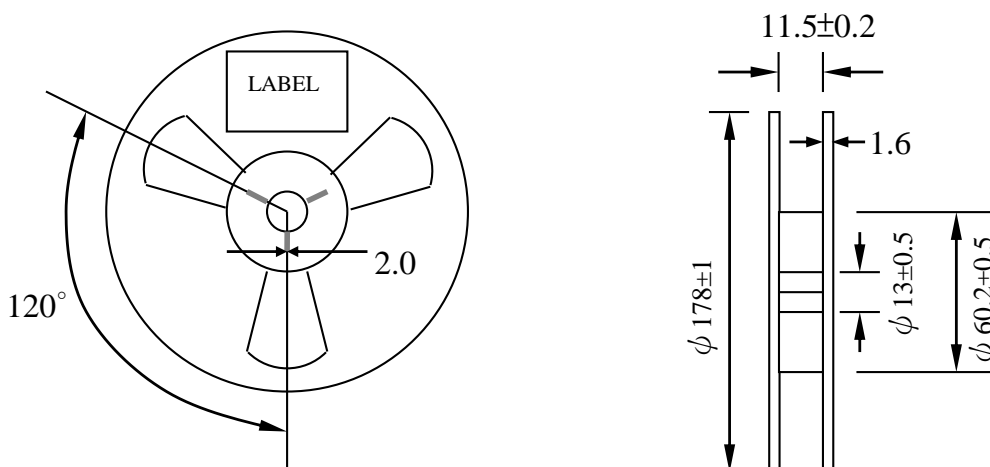

## Reflow Temperature Profile :

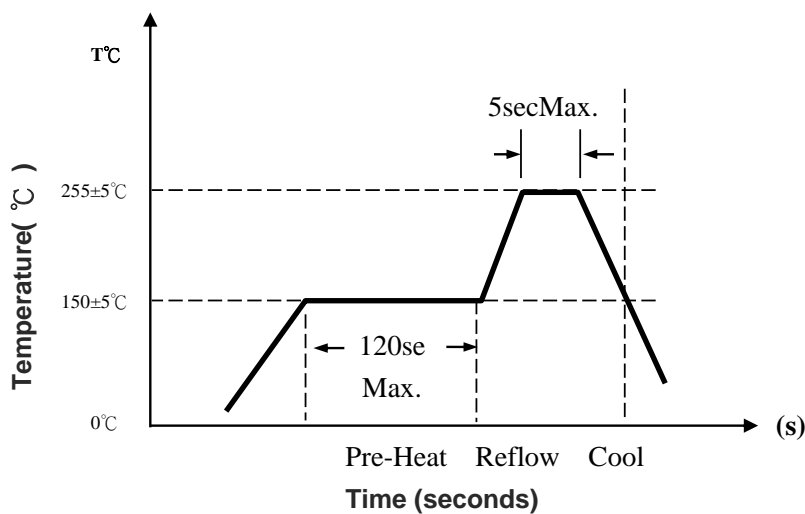

\* Above specification subject to change without prior notice, please consult our sales representative for more information\*

TAIWAN — JENJAAN QUARTEK CORPORATION

Address : 3F-5, No 504 Yun Shan Road, Chung Ho City, Taipei, Taiwan

Tel : +886-2-8221-4498

E-mail : jenjaan@jenjaan.com.tw

Fax : +886-2-8221-4499

Web : <http://www.nsk.com.tw>

FACTORY - DONG GUAN ALLIED PROJECT LIMITED

Address : No. 703, Fu Min Zhong Road, Yang Yong Village, Dalang

Town, Dong Guan, Guang Dong, China Tel : +86-769-8311-9395

Fax : +86-769-8313-0880

E-mail : [alliedj@pub.dgnet.gd.cn](mailto:alliedj@pub.dgnet.gd.cn)